



Research Article

The Cost-Effectiveness Analysis and Optimal Strategy of the Tobacco Control

Liuyong Pang ¹, Sanhong Liu ², Xinan Zhang,³ and Tianhai Tian ⁴

¹School of Mathematics and Statistics, Huanghuai University, Zhumadian 463000, China

²School of Mathematics and Statistics, Hubei University of Science and Technology, Xianning 437100, China

³School of Mathematics and Statistics, Central China Normal University, Wuhan 430079, China

⁴School of Mathematical Sciences, Monash University, Melbourne, VIC 3800, Australia

Correspondence should be addressed to Liuyong Pang; pangliuyong@163.com and Sanhong Liu; jerrylish@163.com

Received 15 July 2018; Revised 20 November 2018; Accepted 9 January 2019; Published 4 February 2019

Academic Editor: Zoran Bursac

Copyright © 2019 Liuyong Pang et al. This is an open access article distributed under the Creative Commons Attribution License, which permits unrestricted use, distribution, and reproduction in any medium, provided the original work is properly cited.

This paper aims at investigating how the media coverage and smoking cessation treatment should be implemented, for a certain period, to reduce the numbers of smokers and patients caused by smoking while minimizing the total cost. To this end, we first propose a new mathematical model without any control strategies to investigate the dynamic behaviors of smoking. Furthermore, we calculate the basic reproduction number \mathcal{R}_0 and discuss the global asymptotic stabilities of the equilibria. Then, from the estimated parameter values, we know that the basic reproduction number \mathcal{R}_0 is more than 1, which reveals that smoking is one of the enduring problems of the society. Hence, we introduce two control measures (media coverage and smoking cessation treatment) into the model. Finally, in order to investigate their effects in smoking control and provide an analytical method for the strategic decision-makers, we apply a concrete example to calculate the incremental cost-effectiveness ratios and analyze the cost-effectiveness of all possible combinations of the two control measures. The results indicate that the combination of media coverage and smoking cessation treatment is the most cost-effective strategy for tobacco control.

1. Introduction

Tobacco use is the single greatest preventable cause of death in the world today. Currently, about 6 million people die from tobacco-related illnesses each year [1]. By 2030, this figure is expected to reach 10 million deaths [2]. If current patterns of smoking continue, about 500 million of the world's population alive today will eventually be killed by smoking, half of them in productive middle age, losing 20 to 25 years of life [3]. Statistical data indicate that it will be very difficult to reduce tobacco-related deaths over the next 30–50 years, unless adult smokers are encouraged to quit [4]. Hence, smoking control and reducing smoking-related death are priority concerns that government organizations must face in the respective countries. Since tobacco contains nicotine which is addictive, it is very difficult to quit smoking [5]. Many different measures have been used to control smoking,

including regulation of the packaging and labelling of tobacco products, higher taxes and prices of cigarettes, setting special smoking areas, mass media campaigns, and psychosocial and pharmacological treatment, all of which aim to enhance public consciousness and help tobacco users to give up smoking and avoid subsequent relapse [6].

Many studies have been conducted to analyze the smoking phenomenon and investigate the effects of different control measures (Ham [7], Yen et al. [8], Ertürk et al. [9], Castillo et al. [10], Sharomi and Gumel [11], and Guerrero et al. [12]). Rowe et al., in 1992 [13], applied a dynamical model to investigate smoking behavior. Zeb et al., in 2013 [14], proposed a model with square-root incidence rate to describe smoking phenomenon. Lahrouz, et al., in 2011 [15], used deterministic and stochastic models to study the dynamic properties of smokers. Guerrero et al., in 2011 [16], used a mathematical model to successfully describe the characteristics of smoking habit in Spain. In 2002, the

Canadian Cancer Society released a study which indicated that setting health warning on cigarette packages is very effective in discouraging smoking [17]. In 2015 [18], we proposed a mathematical model with saturated incidence rate to explore the effects of controlling smoking by setting special smoking areas and raising the price of cigarettes. Results indicate that setting special smoking areas and putting up the price of cigarettes are very effective in reducing the number of smokers.

As a continuation of our previous work, we will further investigate the effects of media coverage and smoking cessation treatment in controlling smoking. We will use a concrete example to provide an analytical method for strategic decision-makers, so that we can find out which strategy is the most cost-effective for all possible combinations of the two tobacco control measures. The organization of this paper is as follows. In Section 2, we will present a new mathematical model to describe the dynamic behavior of smokers. In Section 3, we will derive the concrete form of the basic reproduction number \mathcal{R}_0 and perform stability analysis of the model. In Section 4, we will introduce media coverage and smoking cessation treatment into the model to investigate the effects of two control measures as well as the combination of them. In Section 5, the cost-effectiveness analysis is carried out to gain insight to which strategy is most cost-effective in controlling smoking. Finally, the conclusions are summarized in Section 6.

2. Construction of the Mathematical Model

In order to facilitate discussion, we introduce new occasional smoker class $L(t)$ and patient class $C(t)$ caused by smoking into our previous model [18]. Hence, we divide the total population into six subpopulations: potential smokers, occasional smokers, smokers, temporary quitters, permanent quitters, and patients caused by smoking, with sizes denoted by $P(t)$, $L(t)$, $S(t)$, $Q_t(t)$, $Q_p(t)$, and $C(t)$, respectively.

The transitions among these subpopulations are shown graphically in Figure 1, which shows that the number of potential smokers is increased at a constant recruitment rate Λ . In addition, potential smokers can become occasional smokers via effective “contact” with smokers. The incidence rate is bilinear (β is effective contact rate). The probability that an occasional smoker converts a smoker is assumed as ω . The rate of quitting smoking for smokers is γ . Smokers with the proportion $\gamma\delta$ ($\delta \in (0, 1)$) are shifted into temporary quitters; nevertheless, smokers with the proportion $\gamma(1-\delta)$ become permanent quitters. The relapse rate of temporary quitters is α . The conversion ratios from occasional smokers, smokers, temporary quitters, and permanent quitters to patients caused by smoking are τ , $\tau\xi$, $\eta\theta$ ($\xi, \theta > 1$), and η , respectively. The natural death rates of all the subpopulations are μ , and the mortality rate due to

the disease caused by smoking is d . Hence, we can establish the following model:

$$\begin{cases} \dot{P} = \Lambda - \mu P - \beta SP, \\ \dot{L} = \beta SP - (\mu + \omega + \tau)L, \\ \dot{S} = \omega L + \alpha Q_t - (\mu + \gamma + \tau\xi)S, \\ \dot{Q}_t = \gamma\delta S - (\mu + \alpha + \eta\theta)Q_t, \\ \dot{Q}_p = \gamma(1-\delta)S - (\mu + \eta)Q_p, \\ \dot{C} = \tau L + \tau\xi S + \eta\theta Q_t + \eta Q_p - (\mu + d)C. \end{cases} \quad (1)$$

Thus, the total population size is given by $N(t) = P(t) + L(t) + S(t) + Q_t(t) + Q_p(t) + C(t)$ at time t . Adding all equations of system (1), we can get

$$\dot{N} = \Lambda - \mu N - dC \leq \Lambda - \mu N, \quad (2)$$

which yields that

$$\lim_{t \rightarrow \infty} N(t) = \frac{\Lambda}{\mu}. \quad (3)$$

Therefore, the biologically feasible region

$$\begin{aligned} \Omega = \left\{ (P, L, S, Q_t, Q_p, C) \in R_+^6 : \right. \\ \left. P(t) + L(t) + S(t) + Q_t(t) \right. \\ \left. + Q_p(t) + C(t) \leq \frac{\Lambda}{\mu} \right\}, \end{aligned} \quad (4)$$

is positively invariant.

Since the first four equations in system (1) are independent of the variables Q_p and C , it is sufficient to consider the following reduced system:

$$\begin{cases} \dot{P} = \Lambda - \mu P - \beta SP, \\ \dot{L} = \beta SP - (\mu + \omega + \tau)L, \\ \dot{S} = \omega L + \alpha Q_t - (\mu + \gamma + \tau\xi)S, \\ \dot{Q}_t = \gamma\delta S - (\mu + \alpha + \eta\theta)Q_t. \end{cases} \quad (5)$$

3. Basic Properties of the Model and Parameter Values

In this section, the basic reproductive number \mathcal{R}_0 of model (5) will be calculated, and the stabilities of equilibria will be investigated. For convenience, we note $a = \mu + \omega + \tau$, $b = \mu + \gamma + \tau\xi$, $c = \mu + \alpha + \eta\theta$.

3.1. The Basic Reproductive Number \mathcal{R}_0 . Apparently, model (5) always has a smoking-free equilibrium $E_0(\Lambda/\mu, 0, 0, 0)$. Let $\mathcal{X} = (L, S, Q_t)$, from equation (5), we have

$$\dot{\mathcal{X}} = \mathcal{F}(\mathcal{X}) - \mathcal{V}(\mathcal{X}), \quad (6)$$

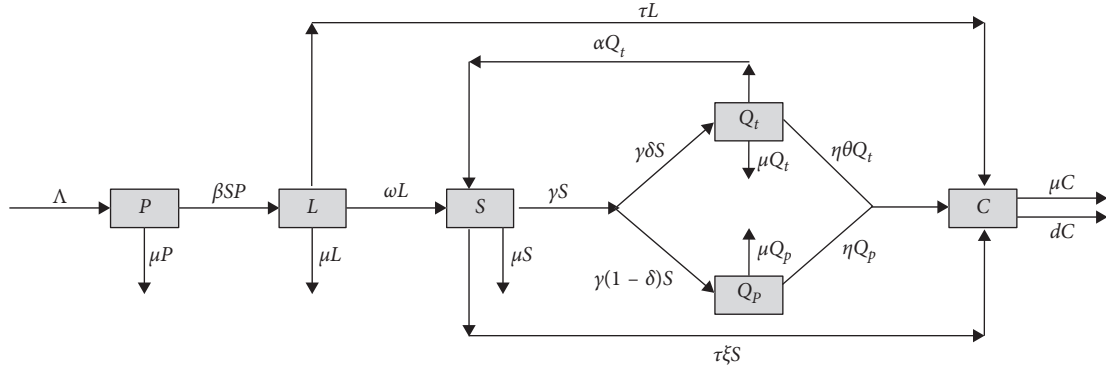

FIGURE 1: Flow chart of system (1).

where

$$\mathcal{F}(\mathcal{X}) = \begin{pmatrix} \beta SP \\ 0 \\ 0 \end{pmatrix}, \quad (7)$$

$$\mathcal{V}(\mathcal{X}) = \begin{pmatrix} aL \\ -\omega L - \alpha Q_t + bS \\ cQ_t - \gamma \delta S \end{pmatrix}.$$

By calculating, we obtain the Jacobina matrices of $\mathcal{F}(\mathcal{X})$ and $\mathcal{V}(\mathcal{X})$ at the smoking-free equilibrium E_0 as follows:

$$F = \begin{bmatrix} 0 & \frac{\beta \Lambda}{\mu} & 0 \\ 0 & 0 & 0 \\ 0 & 0 & 0 \end{bmatrix}, \quad (8)$$

$$V = \begin{bmatrix} a & 0 & 0 \\ -\omega & b & -\alpha \\ 0 & -\gamma \delta & c \end{bmatrix}.$$

The inverse matrix of V is given by

$$V^{-1} = \frac{1}{|V|} \begin{bmatrix} bc - \alpha \gamma \delta & 0 & 0 \\ \omega c & ca & \alpha a \\ \omega \gamma \delta & a \gamma \delta & ab \end{bmatrix}, \quad (9)$$

where

$$|V| = a(bc - \alpha \gamma \delta),$$

$$\begin{aligned} bc - \alpha \gamma \delta &= (\mu + \tau \xi)(\mu + \alpha + \eta \theta) + \gamma(\mu + \alpha + \eta \theta) - \alpha \gamma \delta \\ &= (\mu + \tau \xi)(\mu + \alpha + \eta \theta) + \gamma(\mu + \eta \theta) + \alpha \gamma(1 - \delta). \end{aligned} \quad (10)$$

Clearly, $bc - \alpha \gamma \delta > 0$ when $0 < \delta < 1$. Then $|V| = a(bc - \alpha \gamma \delta) > 0$.

Hence, the basic reproductive number \mathcal{R}_0 (i.e., the spectral radius of FV^{-1} [19]) is equal to

$$\mathcal{R}_0 = \frac{\beta \omega c \Lambda}{\mu a (bc - \alpha \gamma \delta)}. \quad (11)$$

Proposition 1. *If $\mathcal{R}_0 > 1$, an unique positive equilibrium E_* (P_*, L_*, S_*, Q_{t*}) exists in model (5), where $P_* = \Lambda/\mu \mathcal{R}_0$, $L_* = (\Lambda/a)(\mathcal{R}_0 - 1/\mathcal{R}_0)$, $S_* = \mu(\mathcal{R}_0 - 1)/\beta$, and $Q_{t*} = \mu \gamma \delta (\mathcal{R}_0 - 1)/\beta c$.*

3.2. The Stability Analysis of the Model

Theorem 1. *The smoking-free equilibrium E_0 is globally asymptotically stable if $\mathcal{R}_0 < 1$ and unstable if $\mathcal{R}_0 > 1$.*

Proof. The Jacobian matrix of model (5) at E_0 is

$$J(E_0) = \begin{bmatrix} -\mu & 0 & \frac{-\beta \Lambda}{\mu} & 0 \\ 0 & -a & \frac{\beta \Lambda}{\mu} & 0 \\ 0 & \omega & -b & \alpha \\ 0 & 0 & \gamma \delta & -c \end{bmatrix}, \quad (12)$$

whose characteristic equation is given by

$$(\lambda + \mu)(\lambda^3 + a_1 \lambda^2 + a_2 \lambda + a_3) = 0. \quad (13)$$

Obviously, $J(E_0)$ has an eigenvalue $\lambda_1 = -\mu$, and the remaining eigenvalues satisfy

$$\lambda^3 + a_1 \lambda^2 + a_2 \lambda + a_3 = 0, \quad (14)$$

where

$$\begin{aligned}
a_1 &= a + b + c, \\
a_2 &= \left(ab - \frac{\beta\omega\Lambda}{\mu} \right) + ac + (bc - \alpha\gamma\delta) \\
&= \left(\frac{a(bc - \alpha\gamma\delta)}{c} + \frac{\alpha\gamma\delta a}{c} \right) - \frac{a(bc - \alpha\gamma\delta)}{c} \mathcal{R}_0 \\
&\quad + ac + (bc - \alpha\gamma\delta) \\
&= \frac{a(bc - \alpha\gamma\delta)(1 - \mathcal{R}_0)}{c} + \frac{\alpha\gamma\delta a}{c} + ac + (bc - \alpha\gamma\delta), \\
a_3 &= a(bc - \alpha\gamma\delta) - \frac{\beta\omega\Lambda c}{\mu} = a(bc - \alpha\gamma\delta)(1 - \mathcal{R}_0), \\
a_1 a_2 - a_3 &> c \frac{a(bc - \alpha\gamma\delta)(1 - \mathcal{R}_0)}{c} \\
&\quad - a(bc - \alpha\gamma\delta)(1 - \mathcal{R}_0) = 0.
\end{aligned} \tag{15}$$

Given that $\mathcal{R}_0 < 1$, we can obtain $a_2 > 0$, $a_3 > 0$, and $a_1 a_2 - a_3 > 0$. Hence, by Routh–Hurwitz criterion, the smoking-free equilibrium E_0 is locally asymptotically stable if $\mathcal{R}_0 < 1$. If $\mathcal{R}_0 > 1$, then $a_3 < 0$, which implies that the smoking-free equilibrium E_0 is unstable.

To discuss the global stability of E_0 , we use a Lyapunov function

$$V_1 = \omega c \left(P - P^* - P^* \ln \frac{P}{P^*} \right) + \omega c L + acS + a\alpha Q_t, \tag{16}$$

where $P^* = \Lambda/\mu$.

The derivative of V_1 along solutions of model (5) is calculated as follows:

$$\begin{aligned}
\frac{dV_1}{dt} &= \omega c \frac{P - P^*}{P} \frac{dP}{dt} + \omega c \frac{dL}{dt} + ac \frac{dS}{dt} + a\alpha \frac{dQ_t}{dt} \\
&= \omega c \frac{P - P^*}{P} (\Lambda - \mu P - \beta SP) + \omega c (\beta SP - aL) \\
&\quad + ac (\omega L + \alpha Q_t - bS) + a\alpha (\gamma \delta S - cQ_t) \\
&= \omega c \frac{P - P^*}{P} (\mu P^* - \mu P - \beta SP) + \omega c (\beta SP - aL) \\
&\quad + ac (\omega L + \alpha Q_t - bS) + a\alpha (\gamma \delta S - cQ_t) \\
&= -\frac{\mu \omega c}{P} (P - P^*)^2 + \left(\beta \omega c \frac{\Lambda}{\mu} - a(bc - \alpha\gamma\delta) \right) S \\
&= -\frac{\mu \omega c}{P} (P - P^*)^2 + a(bc - \alpha\gamma\delta) (\mathcal{R}_0 - 1) S.
\end{aligned} \tag{17}$$

Then $(dV_1/dt) \leq 0$ if $\mathcal{R}_0 < 1$, and $(dV_1/dt) = 0$ only if $P = P^*$, $S = 0$. Hence, $\{(P, L, S, Q_t) | (dV_1/dt) = 0\} = \{E_0\}$. Therefore, by the LaSalle Invariance Principle, every solution of model (5) approaches E_0 as $t \rightarrow \infty$. \square

Theorem 2. *The unique smoking-present equilibrium E_* is globally asymptotically stable in Ω if $\mathcal{R}_0 > 1$.*

Proof. The Jacobian matrix of system (5) at E_* is

$$J(E_*) = \begin{bmatrix} -\mu - \beta S_* & 0 & -\beta P_* & 0 \\ \beta S_* & -a & \beta P_* & 0 \\ 0 & \omega & -b & \alpha \\ 0 & 0 & \gamma \delta & -c \end{bmatrix}, \tag{18}$$

and the characteristic equation is

$$\lambda^4 + b_1 \lambda^3 + b_2 \lambda^2 + b_3 \lambda + b_4 = 0, \tag{19}$$

where

$$\begin{aligned}
b_1 &= \mu + \beta S_* + a + b + c, \\
b_2 &= (\mu + \beta S_*)(a + b + c) + (bc - \alpha\gamma\delta) \\
&\quad + (ab - \omega\beta P_*) + ac > ab - \omega\beta P_*, \\
b_3 &= (abc - \beta\omega P_* c - \alpha\gamma\delta a) + (\mu + \beta S_*) \\
&\quad ((ab - \omega\beta P_*) + ac + (bc - \alpha\gamma\delta)) + \beta S_* \omega\beta P_*, \\
b_4 &= (\mu + \beta S_*)(abc - \beta\omega P_* c - \alpha\gamma\delta a) + \beta S_* \beta\omega P_* c, \\
b_1 b_2 - b_3 &= (\mu + \beta S_*)^2 (a + b + c) + (a + b + c)((ab - \omega\beta P_*) \\
&\quad + ac + (bc - \alpha\gamma\delta) + (\mu + \beta S_*)(a + b + c)^2 \\
&\quad - \beta S_* \beta\omega P_* > (\mu + \beta S_*)(a + b + c)^2 \\
&\quad - \beta S_* \beta\omega P_* > \beta S_* ab - \beta S_* \beta\omega P_* \\
&= \beta S_* (ab - \beta\omega P_*).
\end{aligned} \tag{20}$$

It is clear that $b_1 > 0$. Note that $ab - \omega\beta P_* = \alpha\gamma\delta a/c$, $abc - \beta\omega P_* c - \alpha\gamma\delta a = c(ab - \omega\beta P_*) - \alpha\gamma\delta a = 0$, then $b_2 > 0$, $b_3 = (\mu + \beta S_*)((ab - \omega\beta P_*) + ac + (bc - \alpha\gamma\delta)) + \beta S_* \omega\beta P_* > 0$, $b_4 = \beta S_* \beta\omega P_* c > 0$, $b_1 b_2 - b_3 > 0$. We can also prove $b_1 b_2 b_3 - b_3^2 - b_1^2 b_4 > 0$ (see Appendix A for details). According to Routh–Hurwitz criterion, the smoking-present equilibrium E_* is locally asymptotically stable. Next, we will apply the novel approach based on the works [20–25] to explore the global stability of the smoking-present equilibrium E_* . From Theorem 1, we know that the smoking-free equilibrium E_0 is unstable if $\mathcal{R}_0 > 1$. The instability of E_0 and $E_0 \in \partial\Omega$ indicates the uniform persistence, that is, there exist a constant $const > 0$, such that

$$\liminf_{t \rightarrow \infty} x(t) > const, \quad x = (P, L, S, Q_t). \tag{21}$$

The uniform persistence, because of boundedness of Ω , is equivalent to the existence of a compact set in the interior of Ω , which is absorbing for system (5).

Denote $x(t) = (P(t), L(t), S(t), Q_t(t))$ and $m(t) = (X(t), Y(t), Z(t), W(t))$, we assign the vector field generated by system (5) to $f(x)$. Then system (5) can be rewritten as

$$\begin{aligned}
\dot{x}(t) &= f(x), \\
\dot{m}(t) &= \frac{\partial f^{[3]}}{\partial x}(x) m,
\end{aligned} \tag{22}$$

where $\partial f^{[3]}/dx$ stands for the third additive compound matrix for system (5) (see Appendix B for details). It is given by

$$\frac{\partial f^{[3]}}{\partial x} = -(3\mu + \beta S)\mathbb{E} + \Phi, \quad (23)$$

$$\Phi = \begin{bmatrix} -(\omega + \tau + \gamma + \tau\xi) & \alpha & 0 & 0 \\ \gamma\delta & -(\omega + \tau + \alpha + \theta\eta) & \beta P & \beta P \\ 0 & \omega & -(\gamma + \tau\xi + \alpha + \eta\theta) & 0 \\ 0 & 0 & \beta S & -(\omega + \tau + \gamma + \theta\eta + \tau\xi + \alpha - \beta S) \end{bmatrix}. \quad (24)$$

Furthermore, the associated linear compound system is given by

$$\begin{cases} \dot{X} = -(3\mu + \beta S + \omega + \tau + \gamma + \tau\xi)X + \alpha Y, \\ \dot{Y} = \gamma\delta X - (3\mu + \beta S + \omega + \tau + \alpha + \theta\eta)Y + \beta P(Z + W), \\ \dot{Z} = \omega Y - (3\mu + \beta S + \gamma + \tau\xi + \alpha + \eta\theta)Z, \\ \dot{W} = \beta SZ - (3\mu + \omega + \gamma + \tau + \tau\xi + \alpha + \theta\eta)W. \end{cases} \quad (25)$$

We construct a Lyapunov function given by

$$V_2(x, m) = \max\left\{|X| + |Y|, \frac{L}{S}(|Z| + |W|)\right\}. \quad (26)$$

Let $\|m\| = |X(t)| + |Y(t)| + |Z(t)| + |W(t)|$. Calculating the derivative of V_2 along the positive solution of system (25) reduces to the following differential inequalities:

$$\begin{aligned} D_+(|X| + |Y|) &\leq -(3\mu + \beta S + \omega + \tau + \gamma + \tau\xi - \gamma\delta)|X| \\ &\quad - (3\mu + \beta S + \omega + \tau + \theta\eta)|Y| + \beta P(|Z| + |W|) \\ &= -(3\mu + \beta S + \omega + \tau + \tau\xi + \gamma(1 - \delta))|X| \\ &\quad - (3\mu + \beta S + \omega + \tau + \theta\eta)|Y| + \beta P(|Z| + |W|) \\ &\leq -(3\mu + \beta S + \omega + \tau)(|X| + |Y|) \\ &\quad + \frac{S}{L}\beta P\left(\frac{L}{S}(|Z| + |W|)\right). \end{aligned} \quad (27)$$

Similarly, we get

where \mathbb{E} is an identity matrix and

$$\begin{aligned} D_+\left[\frac{L}{S}(|Z| + |W|)\right] &= \frac{L}{S}\left(\frac{\dot{L}}{L} - \frac{\dot{S}}{S}\right)(|Z| + |W|) \\ &\quad + \frac{L}{S}D_+(|Z| + |W|) \\ &\leq \left(\frac{\dot{L}}{L} - \frac{\dot{S}}{S} - (3\mu + \gamma + \tau\xi + \alpha + \theta\eta)\right) \\ &\quad \cdot \left(\frac{L}{S}(|Z| + |W|)\right) + \frac{\omega L}{S}|Y| \\ &\leq \frac{\omega L}{S}(|X| + |Y|) \\ &\quad + \left(\frac{\dot{L}}{L} - \frac{\dot{S}}{S} - (3\mu + \gamma + \tau\xi + \alpha + \theta\eta)\right) \\ &\quad \cdot \left(\frac{L}{S}(|Z| + |W|)\right). \end{aligned} \quad (28)$$

Combining (27) and (28) yields

$$D_+|V_2(t)| \leq \sup\{h_1(t), h_2(t)\}V_2(t), \quad (29)$$

where

$$\begin{cases} h_1(t) = -(3\mu + \beta S + \omega + \tau) + \frac{S}{L}\beta P, \\ h_2(t) = \frac{\omega L}{S} + \left(\frac{\dot{L}}{L} - \frac{\dot{S}}{S} - (3\mu + \gamma + \tau\xi + \alpha + \theta\eta)\right). \end{cases} \quad (30)$$

Form system (5), we have

$$\begin{cases} \frac{\dot{L}}{L} = \frac{\beta SP}{L} - (\mu + \omega + \tau), \\ \frac{\dot{S}}{S} = \frac{\omega L}{S} + \frac{\alpha Q_t}{S} - (\mu + \gamma + \tau\xi). \end{cases} \quad (31)$$

Hence,

$$h_1(t) = \frac{\dot{L}}{L} - 2\mu - \beta S \leq \frac{\dot{L}}{L} - 2\mu, \quad (32)$$

$$h_1(t) = \frac{\dot{L}}{L} - 2\mu - \frac{\alpha Q_t}{S} - \alpha - \theta\eta \leq \frac{\dot{L}}{L} - 2\mu,$$

which leads to

$$D_+ V_2(t) \leq \left(\frac{\dot{L}}{L} - 2\mu \right) V_2(t). \quad (33)$$

Accordingly, from (33), we can obtain

$$V_2(t) \leq \frac{L(t)}{L(0)} V_2(0) e^{-2\mu t} \leq \frac{\Lambda V_2(0)}{\mu L(0)} e^{-2\mu t} \longrightarrow 0, \text{ as } t \longrightarrow \infty, \quad (34)$$

which indicates that the associated linear compound system (25) is asymptotically stable. Hence, by results found in [20–23], the smoking-present equilibrium E_* is globally asymptotically stable. \square

3.3. Parameter Values. In order to estimate the parameter values of the model (1), we make some reasonable hypothesis. Assume that the average age of people is 70 years old; then, we estimate the natural death rate $\mu = 1/(365 * 70) \approx 4 \times 10^{-5}$ persons per day. We suppose to select a community with size about $1.5 * 10^9$ person as the object of our investigation. Thus, the recruitment rate of potential smokers is $\Lambda \approx 1.5 * 10^9 * \mu = 6000$ persons per day. The convert rate of occasional smokers into smokers is estimated as $\omega = 0.03$ persons per day [14]. The average duration of smoking for a smoker is assumed as 10 years. Thus, the quit rate of a smoker is estimated as $\gamma = 1/(365 * 10) \approx 2.74 \times 10^{-4}$ persons per day. The ratio of quitters who temporarily quit smoking is assumed as $\delta = 0.2$. The average time-span for temporary quitters from the time quitting smoking to the time starting smoking again is assumed as 2 years, then $\alpha = 1/(2 * 365) = 0.0014$ persons per day. The average duration after which an occasional smoker will develop smoking-related illnesses is about 8 years. Thus, τ is estimated as $1/(8 * 365) = 3.42 \times 10^{-4}$ persons per day. Based on that, a smoker have a higher probability of developing smoking-related illnesses than an occasional smoker; we assume that a smoker develops smoking-related illnesses at a rate $\tau\xi$ (where $\xi = 3$). Similarly, the average duration after which a permanent quitter will develop smoking-related illnesses is assumed as 10 years. Hence, η is estimated as $1/(10 * 365) = 2.74 \times 10^{-4}$ persons per day. Because that a temporary quitter have a higher probability of developing smoking-related illnesses than a permanent quitter, we assume that a temporary quitter develops smoking-related illnesses at a rate $\eta\theta$ (where $\theta = 6$). It is assumed that an individual with smoking-related illnesses can averagely live for 20 years. Thus, the death rate due to illnesses is estimated as $d = 1/(365 * 20) = 1.37 \times 10^{-4}$. Goyal, in 2014, applied the data derived from Canada to deduce the effective contact rate between the potential smoker and the smoker as 8.2192×10^{-7} persons per year

[26]. We take it as the effective contact rate β of this paper, i.e., $\beta = 8.2192 \times 10^{-7}/365 = 1.3177 \times 10^{-11}$ persons per day. We list each parameter value of system (1) in Table 1 to provide a quick reference.

From the reasonably estimated parameter values in Table 1, we can calculate the basic reproductive number $\mathcal{R}_0 = 1.4840 > 1$, which indicates that the smoking-present equilibrium E_* is globally asymptotically stable, i.e., smoking is one of the enduring problems of society. Corresponding time series plots with different initial values of $S(t)$ are shown in Figure 2.

4. Application of Optimal Control to the Tobacco Control Model

Based on the analysis results above mentioned, we know that smoking will become a huge social problem in the absence of any control measure. In order to combat this trouble, we will investigate the effects of media coverage and smoking cessation treatment in controlling smoking. (a) Effects of media coverage. The mass media campaigns which propagate that smoking is very harmful to health not only can cut down the relapse probability of an ex-smoker who returns to cigarettes and reduce the convert probability of an occasional smoker into a smoker, but also can decrease the probability of becoming an occasional smoker to a potential smoker due to the contact with a smoker. Based on that, the probability of a potential smoker becoming an occasional smoker is not only influenced by the media coverage, and we denote the relapse rate of an ex-smoker, the conversion rate of an occasional smoker into a smoker, and the probability of a potential smoker becoming an occasional smoker reduced by media coverage as $\mu_1(t)$, $\mu_2(t)$, and $b\mu_1(t)$, (where $b_1 \in (0, 1)$), respectively. (b) Effects of smoking cessation treatment. Many treatment measures can be used for smoking cessation, including behavioral counseling and medications (such as nicotine replacement therapy and varenicline). These treatment measures do not only reduce withdrawal symptoms but also increase the success rate of quitting smoking. $u_2(t)$ represents the success rate of quitting smoking enhanced by smoking cessation treatment. Taking into account the extensions made above, system (1) is modified as the following system:

$$\begin{cases} \dot{P} = \Lambda - \mu P - \beta(1 - b_1 u_1)SP, \\ \dot{L} = \beta(1 - b_1 u_1)SP - [\mu + \omega(1 - u_1) + \tau]L, \\ \dot{S} = \omega(1 - u_1)L + \alpha(1 - u_1)Q_t - [\mu + \gamma(1 + u_2) + \tau\xi]S, \\ \dot{Q}_t = \gamma(1 + u_2)\delta S - [\mu + \alpha(1 - u_1) + \eta\theta]Q_t, \\ \dot{Q}_p = \gamma(1 + u_2)(1 - \delta)S - (\mu + \eta)Q_p, \\ \dot{C} = \tau L + \tau\xi S + \eta\theta Q_t + \eta Q_p - (\mu + d)C. \end{cases} \quad (35)$$

Our aim is to minimize the cost arising from the consumption of the social resources for smokers and the consumption of the medical and health resources for patients caused by smoking, as well as the costs incurred by media propaganda and smoking cessation treatment. For this end, the total cost functional is defined as

TABLE 1: The biological meanings and estimated values of parameters.

Parameter	Description	Value	Source
μ	The natural death rate	4×10^{-5}	[18]
Λ	The recruitment rate	6000	Assumed
β	The effective contact rate	1.3177×10^{-11}	[26]
ω	The ratio of occasional smoker class converted to smoker class	0.03	[14]
γ	The quit ratio of smokers	2.74×10^{-4}	[18]
δ	The ratio of quitters who quit smoking temporarily	0.200	[18]
α	The relapse rate of temporal quitters	0.0014	[18]
τ	The ratio of occasional smokers who develop smoking-related illnesses	3.42×10^{-4}	Assumed
ξ	A positive constant	3.00	Assumed
η	The ratio of permanent quitters who develop smoking-related illnesses	2.74×10^{-4}	Assumed
θ	A positive constant	6.00	Assumed
d	The death rate due to smoking-related illnesses	1.37×10^{-4}	Assumed

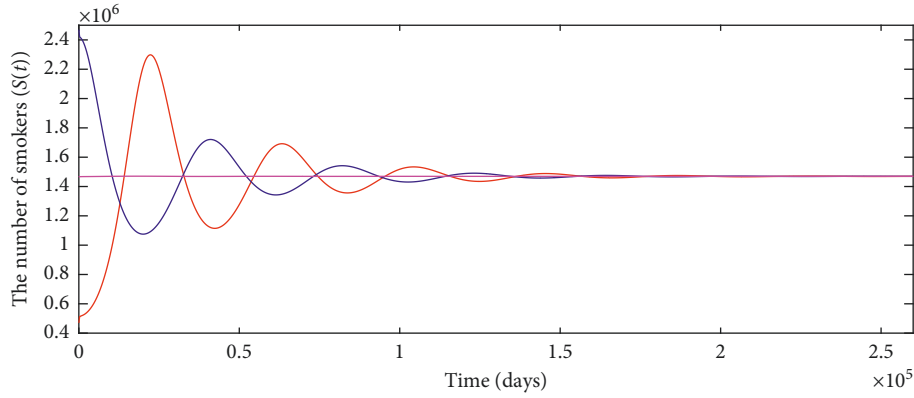
FIGURE 2: Time series plots with different initial values of $S(t)$ when $\mathcal{R}_0 = 1.4840 > 1$.

$$C_T(u) = \int_0^{t_f} \left[\varepsilon_0 L(t) + \varepsilon_1 S(t) + \varepsilon_2 C(t) + \frac{\varepsilon_3}{2} u_1^2(t) + \frac{\varepsilon_4}{2} u_2^2(t) \right] dt, \quad (36)$$

subject to the state system given by (35). We choose a linear functional for the costs arising from the occasional smokers, the smokers, and the patients. ε_0 and ε_1 represent the costs arising from the consumption of the social resources for every occasional smoker and smoker, respectively. ε_2 denotes the cost produced by the consumption of the medical and health resources for every patient caused by smoking. However, we choose a quadratic functional to represent the costs incurred by media coverage and smoking cessation treatment; such a cost functional has been frequently used in [27–34]. ε_3 and ε_4 are cost weights associated with the controls u_1 and u_2 , respectively. We seek to find an optimal control pair, u_1^* and u_2^* , such that

$$C_T(u_1^*, u_2^*) = \min_{\Phi} \{C_T(u_1, u_2)\}, \quad (37)$$

where the control set

$$\Phi = \left\{ (u_1, u_2) \in (L^\infty(0, t_f))^2 \mid 0 \leq u_1(t) \leq u_{1\max}, \right. \\ \left. 0 \leq u_2(t) \leq u_{2\max}, t \in [0, t_f] \right\}. \quad (38)$$

Then the Hamiltonian H associated with problems (35)–(37) reads

$$H = \varepsilon_0 L(t) + \varepsilon_1 S(t) + \varepsilon_2 C(t) + \frac{\varepsilon_3}{2} u_1^2(t) \\ + \frac{\varepsilon_4}{2} u_2^2(t) + \lambda_1 \frac{dP}{dt} + \lambda_2 \frac{dL}{dt} + \lambda_3 \frac{dS}{dt} \\ + \lambda_4 \frac{dQ_t}{dt} + \lambda_5 \frac{dQ_p}{dt} + \lambda_6 \frac{dC}{dt}, \quad (39)$$

where λ_i ($i = 1, 2, \dots, 6$) are the solutions of the following equalities:

$$\begin{aligned} \lambda_1 &= \lambda_1 [\mu + \beta(1 - b_1 u_1)S] - \lambda_2 \beta(1 - b_1 u_1)S, \\ \lambda_2 &= -\varepsilon_0 + \lambda_2 [\mu + \omega(1 - u_1) + \tau] - \lambda_3 \omega(1 - u_1) - \lambda_6 \tau, \\ \lambda_3 &= -\varepsilon_1 + (\lambda_1 - \lambda_2) \beta(1 - u_1)P + \lambda_3 [\mu + \gamma(1 + u_2) + \tau \xi] \\ &\quad - \lambda_4 \gamma(1 + u_2) \delta - \lambda_5 \gamma(1 + u_2)(1 - \delta) - \lambda_6 \tau \xi, \\ \lambda_4 &= -\lambda_3 \alpha(1 - u_1) + \lambda_4 [\mu + \alpha(1 - u_1) + \eta \theta] - \lambda_6 \eta \theta, \\ \lambda_5 &= \lambda_5 (\mu + \eta) - \lambda_6 \eta, \\ \lambda_6 &= -\varepsilon_2 + \lambda_6 (\mu + d), \end{aligned} \quad (40)$$

satisfying the transversality condition

$$\lambda_i(t_f) = 0, \quad i = 1, \dots, 6. \quad (41)$$

By Pontryagin's Maximum Principle [35] and results obtained from Fleming and Rishel [36–38], we can get the following result:

Theorem 3. *There exists an optimal strategy $u^* = (u_1^*, u_2^*) \in \Phi$ such that*

$$C_T(u_1^*, u_2^*) = \min_{(u_1, u_2) \in \Phi} C_T(u_1, u_2), \quad (42)$$

then the optimal controls $u_1^*, u_2^* \in \Phi$ are given by

$$\begin{aligned} u_1^*(t) &= \min \left\{ u_{1\max}, \max \left\{ 0, \frac{(\lambda_2 - \lambda_1)b_1\beta S^*P^* + (\lambda_3 - \lambda_2)\omega L^* + (\lambda_3 - \lambda_4)\alpha Q_t^*}{\varepsilon_3} \right\} \right\}, \\ u_2^*(t) &= \min \left\{ u_{2\max}, \max \left\{ 0, \frac{(\lambda_3 - \lambda_4\delta - \lambda_5(1 - \delta))\gamma S^*}{\varepsilon_4} \right\} \right\}, \end{aligned} \quad (43)$$

where λ_i ($i = 1, 2, \dots, 6$) are the solutions of (40) and (41), and P^* , L^* , S^* , Q_t^* are optimal state solutions with associated optimal control variables (u_1^*, u_2^*) .

Proof. In order to prove the existence of optimal control strategy u^* minimizing $C_T(u)$, based on the method mentioned in [34, 36, 37], we need to verify whether the following hypotheses are met:

- (H1) The control set and state variables are nonempty
- (H2) The control set Φ is closed and convex
- (H3) The integrand of the objective functional C_T is convex in Φ and satisfies

$$\begin{aligned} \varepsilon_0 L(t) + \varepsilon_1 S(t) + \varepsilon_2 C(t) + \frac{\varepsilon_3}{2} u_1^2(t) \\ + \frac{\varepsilon_4}{2} u_2^2(t) \geq \nu_2 (u_1^2(t) + u_2^2(t))^{\nu_3/2} - \nu_1, \end{aligned} \quad (44)$$

where $\nu_1, \nu_2 > 0$ and $\nu_3 > 1$.

(H4) The right hand side of system (35) is bounded by the sum of the bounded control variables and state variables and can be written as a linear equation of control variables with coefficient depending on time and state

From $P(t) + L(t) + S(t) + Q_t(t) + Q_P(t) + C(t) \leq \Lambda/\mu$, we know that the solutions of state system are bounded. Furthermore, based on the result in [39], we can obtain the existence of the solution of system (35) with bounded coefficients. Hence, condition (H1) is satisfied. It is obvious that our control set Φ is closed and convex defined by $\Phi = \{(u_1, u_2) \in (L^\infty(0, t_f))^2 \mid 0 \leq u_1(t) \leq u_{1\max},$

$0 \leq u_2(t) \leq u_{2\max}, t \in [0, t_f]\}$, which satisfies condition (H2). Since the integrand of the objective functional is positive and quadratic in the control variables, it is convex. Notice that

$$\begin{aligned} \varepsilon_0 L(t) + \varepsilon_1 S(t) + \varepsilon_2 C(t) + \frac{\varepsilon_3}{2} u_1^2(t) \\ + \frac{\varepsilon_4}{2} u_2^2(t) \geq \frac{\min\{\varepsilon_3, \varepsilon_4\}}{2} (u_1^2(t) + u_2^2(t)) \\ \geq \nu_2 (u_1^2(t) + u_2^2(t))^{\nu_3/2} - \nu_1, \end{aligned} \quad (45)$$

with $\nu_1 > 0$, $\nu_2 = (\min\{\varepsilon_3, \varepsilon_4\}/2) > 0$, and $\nu_3 = 2$. Hence, the condition (H3) is satisfied. By definition, each right hand side of system (35) is continuous and can be written as a linear function of control $u = (u_1, u_2)$ with coefficients depending on time and states, which satisfies the condition (H4). Therefore, we conclude that there exists an optimal control.

Furthermore, by equating to zero the derivatives of the Hamiltonian with respect to the controls, we obtain

$$\begin{aligned} u_1 &= \frac{(\lambda_2 - \lambda_1)b_1\beta S^*P^* + (\lambda_3 - \lambda_2)\omega L^* + (\lambda_3 - \lambda_4)\alpha Q_t^*}{\varepsilon_3}, \\ u_2 &= \frac{(\lambda_3 - \lambda_4\delta - \lambda_5(1 - \delta))\gamma S^*}{\varepsilon_4}. \end{aligned} \quad (46)$$

Using the property of the control space, we have

$$\begin{aligned} u_1^*(t) &= \min \left\{ u_{1\max}, \max \left\{ 0, \frac{(\lambda_2 - \lambda_1)b_1\beta S^*P^* + (\lambda_3 - \lambda_2)\omega L^* + (\lambda_3 - \lambda_4)\alpha Q_t^*}{\varepsilon_3} \right\} \right\}, \\ u_2^*(t) &= \min \left\{ u_{2\max}, \max \left\{ 0, \frac{(\lambda_3 - \lambda_4\delta - \lambda_5(1 - \delta))\gamma S^*}{\varepsilon_4} \right\} \right\}. \end{aligned} \quad (47)$$

To find out the optimal control variables and state variables, we will numerically solve the above systems (35), (40), (41), and (43). \square

5. Numerical Results and Cost-Effectiveness Analysis

In this section, numerical simulations and cost-effectiveness analysis [40] are performed to illustrate the effects of control smoking by different control strategies. We apply the parameter values listed in Table 1 to obtain numerical results for the optimal system by using a forward-backward iterative method [41]. The cost-effectiveness of alternative combinations of the two control measures will be investigated.

According to the method mentioned in [27, 29, 40] and our prior work [42], we will focus on comparing the following three control strategies. **Strategy a:** The combination of media coverage and smoking cessation treatment is implemented to combat smoking habit. For this case, u_1 and u_2 are defined as control variables. **Strategy b:** Single media coverage is performed. In this case, only u_1 is taken as control variable. **Strategy c:** Single treatment measure is carried out. In this case, only u_2 is seen as the control variable. Our purpose is to provide an analytical method for the strategic decision-makers. Due to the lack of the available literatures and data, as an example, we take cost coefficients ε_i ($i = 0, 1, 2, 3, 4$) as $\varepsilon_0 = 1$, $\varepsilon_1 = 1$, $\varepsilon_2 = 1$, $\varepsilon_3 = 36$, $\varepsilon_4 = 36$, and $b_1 = 0.8$, respectively. The maximums of $u_1(t)$ and $u_2(t)$ are taken as 1 and 4, respectively. The smoking-present equilibrium E_* is served as the initial point of system (35), and the control period is taken as 20 years, i.e., $t_f = 20 \times 365 = 7300$ days (where $E_* = (1.011 \times 10^8, 6.4411 \times 10^4, 1.4693 \times 10^6, 2.6111 \times 10^4, 1.0258 \times 10^6, 1.0472 \times 10^7)$).

5.1. Strategy a: The Combination of Media Coverage and Smoking Cessation Treatment. For this strategy, corresponding optimal control variables u_1^* , u_2^* and optimal state variables $S^*(t)$, $C^*(t)$ are depicted in Figures 3(a)–3(d), respectively.

Figures 3(a) and 3(b) tell us that media coverage intensity and treatment intensity almost always take their maximum and then subsequently reduce to zero. From Figures 3(c) and 3(d), we know that adopting optimal combined control strategies $u_1^*(t)$, $u_2^*(t)$ can significantly reduce the numbers of smokers and patients with smoking-related illnesses. In order to more clearly show the efficacy of strategy **a**, the efficacy function of smokers averted by strategy **a** is defined as

$$E_{aS} = \frac{S(0) - S_a^*(t)}{S(0)}, \quad (48)$$

where $S(0)$ is the initial number of smokers and $S_a^*(t)$ is the corresponding optimal state associated with optimal control strategy **a**. Efficacy function of smokers $E_{aS}(t)$ is depicted in Figure 4(a), which indicates that taking the optimal combined control strategy **a** can reduce the number of smokers

be highest up to more than 98%. Similarly, the efficacy function of patients with smoking-related illnesses averted by strategy **a** is defined as

$$E_{aC} = \frac{C(0) - C_a^*(t)}{C(0)}, \quad (49)$$

where $C(0)$ represents the initial number of patients with smoking-related illnesses and $C_a^*(t)$ is the corresponding optimal state associated with optimal control strategy **a**. The corresponding plot is shown in Figure 4(b), from which we can know that taking the optimal control measures $u_1^*(t)$, $u_2^*(t)$ can make decrement of patients be highest up to more than 60%. In a word, optimal strategy **a** is very effective in controlling smoking.

To investigate the the cost-effectiveness of different control strategies, the total occasional smokers averted by the optimal strategy **a** during the time period t_f is firstly defined as

$$A_{aL} = t_f L(0) - \int_0^{t_f} L_a^*(t) dt, \quad (50)$$

where $L_a^*(t)$ is optimal state associated with the optimal strategy **a** and $L(0)$ is the initial number of occasional smokers. Similarly, the total smokers and patients with smoking-related illness averted by the optimal strategy **a** during the time period t_f are, respectively, defined as

$$\begin{aligned} A_{aS} &= t_f S(0) - \int_0^{t_f} S_a^*(t) dt, \\ A_{aC} &= t_f C(0) - \int_0^{t_f} C_a^*(t) dt, \end{aligned} \quad (51)$$

where $S_a^*(t)$ and $C_a^*(t)$ are optimal states associated with the optimal control of strategy **a**, and $S(0)$ and $C(0)$ are the initial numbers of smokers and patients, respectively. We hope that the numbers of occasional smokers and smokers are as less as possible. Especially, we further expect that the number of patients with smoking-related illnesses approaches to 0. Hence, we use the weighted average of occasional smokers, smokers, and patients as the total cases averted by the optimal strategy **a** during the time period t_f , i.e.,

$$TA_a = \frac{\varepsilon_0 A_{aL} + \varepsilon_1 A_{aS} + \varepsilon_2 A_{aC}}{\varepsilon_0 + \varepsilon_1 + \varepsilon_2}. \quad (52)$$

For strategy **a**, we can, respectively, calculate the values of A_{aL} , A_{aS} , A_{aC} , TA_a , and C_{Ta} (see Table 2).

5.2. Strategies b and c: Single Media Coverage and Single Smoking Cessation Treatment. For single media converge strategy, we take u_1 as the control variable to minimize the objective functional C_T (36) and take $u_2 = 0$. Similarly, for single smoking cessation treatment strategy, we take u_2 as the control variable and set $u_1 = 0$. The optimal control variables of $u_1^*(t)$ and $u_2^*(t)$ for strategies **b** and **c** are shown in Figures 5(a) and 5(b), respectively. Corresponding optimal state variables $S^*(t)$ and $P^*(t)$ are depicted in Figures 5(c) and 5(d), respectively.

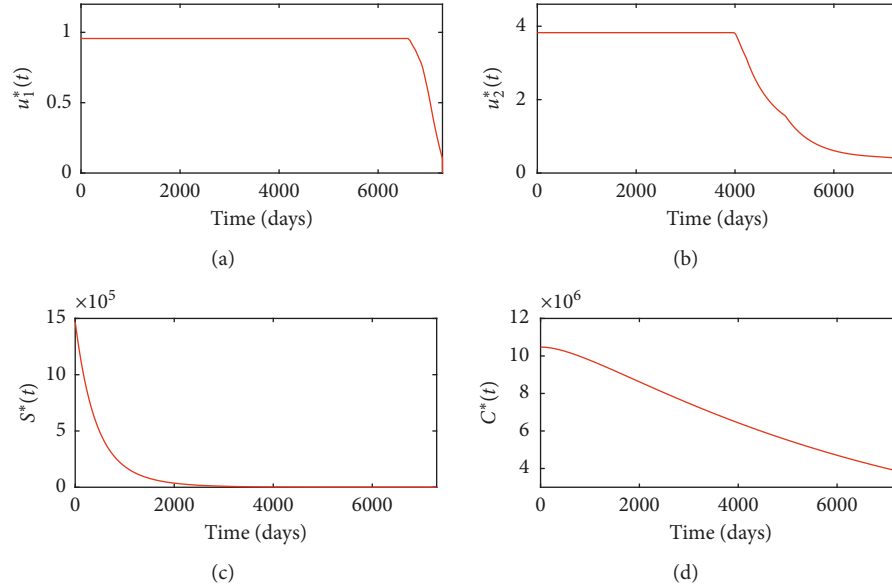

FIGURE 3: (a) Optimal control variable $u_1^*(t)$ for strategy **a**; (b) optimal control variable $u_2^*(t)$ for strategy **a**; (c) optimal state variable $S^*(t)$ for strategy **a**; (d) optimal state variable $C^*(t)$ for strategy **a**.

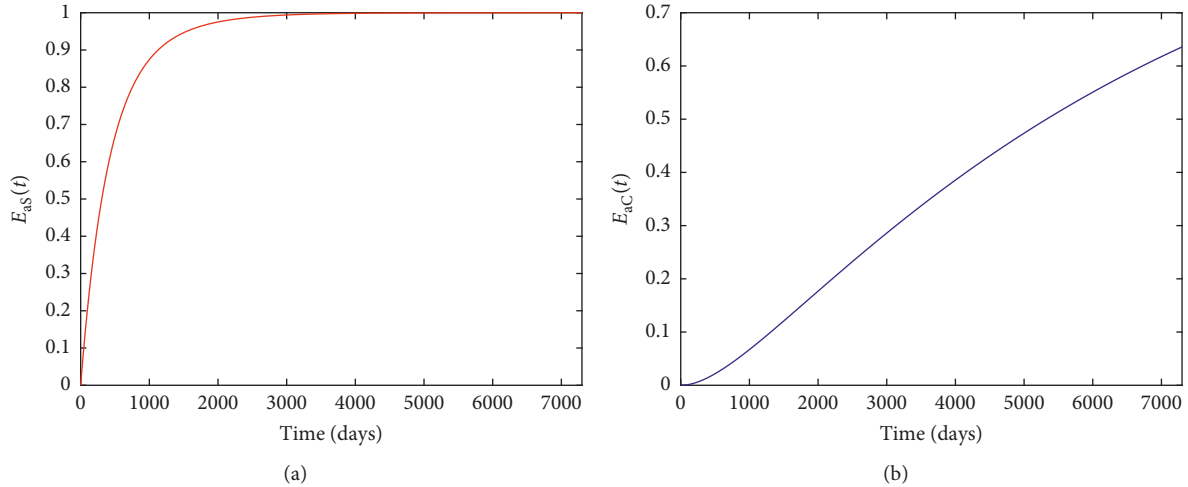

FIGURE 4: (a) Efficacy function $E_{aS}(t)$ for strategy **a**; (b) efficacy function $E_{aC}(t)$ for strategy **a**.

Similarly, the efficacy functions of smokers and patients averted for strategy k ($k=\mathbf{b}$ or \mathbf{c}) are also, respectively, defined as

$$E_{kS} = \frac{S(0) - S_k^*(t)}{S(0)}, \quad (53)$$

$$E_{kC} = \frac{C(0) - C_k^*(t)}{C(0)}, \quad (k = \mathbf{b} \text{ or } \mathbf{c}).$$

The corresponding time series of efficacy functions are depicted in Figures 6(a) and 6(b), respectively.

The results of the strategy **b** are denoted by the blue dotted lines, while the results of the strategy **c** are represented by the red solid lines. From Figures 5(a), 5(c), 5(d), 6(a), and 6(b), we know that taking single high-intensity media coverage can effectively combat smoking behavior.

Similarly, Figures 5(b)–5(d) tell us that single treatment measure can also obviously reduce the numbers of smokers and patients with smoking-related illnesses. In comparison, single optimal media coverage measure is more effective than single treatment strategy in controlling smoking and reducing the number of patients with smoking-related illnesses. Furthermore, for single media coverage strategy **b** and single smoking cessation strategy **c**, the values of A_{kL} , A_{kS} , A_{kC} , TA_k , and C_{Tk} ($k=\mathbf{b}$ or \mathbf{c}) are, respectively, calculated and listed in Table 2.

5.3. Cost-Effectiveness Analysis. In this subsection, the cost-effectiveness of the three alternative strategies is investigated by the incremental cost-effectiveness ratio mentioned in [27–29, 40]. The differences between the costs and health

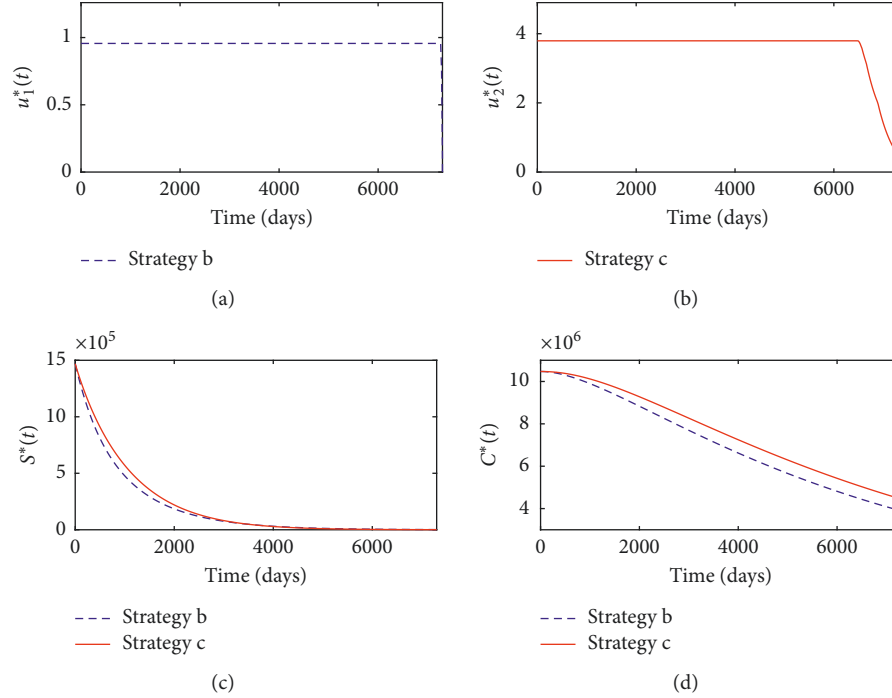

FIGURE 5: (a) Optimal control $u_1^*(t)$ for strategy **b**; (b) optimal control $u_2^*(t)$ for strategy **c**; (c) optimal state variables $S^*(t)$ for strategies **b** and **c**, respectively; (d) optimal state variables $C^*(t)$ for strategies **b** and **c**, respectively.

TABLE 2: The cases averted and the total cost.

Strategy k	A_{kL}	A_{kS}	A_{kC}	TA_k	C_{Tk}
a	3.0392×10^8	1.0016×10^{10}	2.5468×10^{10}	1.1929×10^{10}	5.1856×10^{10}
b	1.8916×10^4	9.3533×10^9	2.4397×10^{10}	1.1313×10^{10}	5.3703×10^{10}
c	4.0424×10^8	9.1958×10^9	2.0816×10^{10}	1.0139×10^{10}	5.7229×10^{10}

outcomes of different control strategies are compared by this ratio, which is used to investigate the additional cost per additional health outcome. Based on the method mentioned in [27–29, 40], we rank the strategies in increasing order of effectiveness for the total cases (including occasional smokers, smokers, and patients) averted by strategy \mathbf{k} ($\mathbf{k} = \mathbf{a}, \mathbf{b}, \mathbf{c}$) and list them in Table 3.

Next, we define and calculate the ICERs as follows:

$$\begin{aligned} \text{ICER}_c &= \frac{C_{Tc}}{TA_c} = \frac{5.7229 \times 10^{10}}{1.0139 \times 10^{10}} = 5.6444, \\ \text{ICER}_b &= \frac{C_{Tb} - C_{Tc}}{TA_b - TA_c} = \frac{5.3703 \times 10^{10} - 5.7229 \times 10^{10}}{1.1313 \times 10^{10} - 1.0139 \times 10^{10}} = -3.0034. \end{aligned} \quad (54)$$

Comparing ICER_b with ICER_c reveals a cost-saving of 3.0034 for strategy **b** over strategy **c**, which indicates that strategy **b** is more inexpensive and more effective than strategy **c**. Hence, the single smoking cessation strategy is ruled out from the set of alternatives strategies. We rule out strategy **c** and further compare strategy **a** and strategy **b**. Hence, we can get the following values of the ICER:

$$\text{ICER}_b = \frac{C_{Tb}}{TA_b} = \frac{5.3703 \times 10^{10}}{1.1313 \times 10^{10}} = 4.7470,$$

$$\text{ICER}_a = \frac{C_{Ta} - C_{Tb}}{TA_a - TA_b} = \frac{5.1856 \times 10^{10} - 5.3703 \times 10^{10}}{1.1929 \times 10^{10} - 1.1313 \times 10^{10}} = -0.2315. \quad (55)$$

From above calculations, we know that strategy **b** is more costly and less effective than strategy **a**. Therefore, strategy **b** is excluded. Consequently, strategy **a**, combining of mass media and smoking cessation treatment, is the most cost-effective among the three strategies considered.

6. Further Discussion and Conclusion

In this paper, we apply an example to investigate the effects of media coverage and smoking cessation treatment on controlling smoking. Firstly, we give the concrete form of the basic reproduction number \mathcal{R}_0 and discuss the existence and stabilities of equilibria. Secondly, from the estimated parameter values, we obtain the basic reproduction

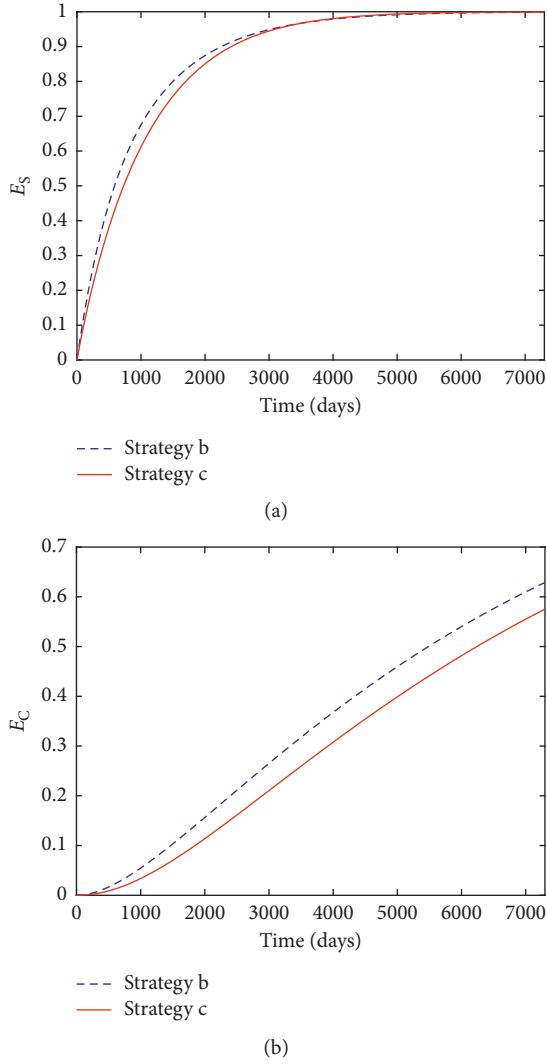

FIGURE 6: (a) Efficacy functions of $E_{kS}(t)$ ($k = \mathbf{b}$ and \mathbf{c}) for strategies \mathbf{b} and \mathbf{c} ; (b) efficacy functions of $E_{kC}(t)$ ($k = \mathbf{b}$ and \mathbf{c}) for strategies \mathbf{b} and \mathbf{c} .

TABLE 3: Incremental cost-effectiveness ratio in increasing order of total cases averted.

Strategy k	Total cases averted TA	Total cost C_T	ICER
No strategy	0	0	–
Strategy \mathbf{c}	1.0139×10^{10}	5.7229×10^{10}	5.6444
Strategy \mathbf{b}	1.1313×10^{10}	5.3703×10^{10}	-3.0034
Strategy \mathbf{a}	1.1929×10^{10}	5.1856×10^{10}	-0.2315

number $\mathcal{R}_0 = 1.4840 > 1$, which indicates that the smoking is one of the enduring problems of society. Hence, we introduce two control measures (media coverage and smoking cessation treatment) into the previous model to find out which strategy is the most effective in combating

smoking behavior. Finally, from the numerical results and cost-effectiveness analysis, we conclude that the combination of media coverage and smoking cessation treatment is the most cost-effective strategy. Although we have investigated the effects of media coverage and smoking cessation treatment in controlling smoking, we still do not consider the impact of second-hand smoke on nonsmokers. We will use the real data about tobacco in China to model the parameters and discuss the impact of second-hand smoke on individuals, society, and economy in our future work.

Appendix

A. Proof of $b_1 b_2 b_3 - b_3^2 - b_1^2 b_4 > 0$

Proof. For the sake of convenience, we let $x = bc - \alpha\gamma\delta$. Note that $bc - \alpha\gamma\delta > 0$, so $x > 0$.

Since

$$\begin{aligned}
 b_1 &= \mu + \beta S_* + a + b + c, \\
 b_2 &= (\mu + \beta S_*)(a + b + c) + (bc - \alpha\gamma\delta) + (ab - \omega\beta P_*) + ac, \\
 b_3 &= (\mu + \beta S_*)((bc - \alpha\gamma\delta) + (ab - \omega\beta P_*) + ac) + \beta S_* \omega\beta P_*, \\
 b_4 &= \beta S_* \beta \omega P_* c,
 \end{aligned} \tag{A.1}$$

where

$$\begin{aligned}
 a &= \mu + \omega + \tau, \\
 b &= \mu + \gamma + \tau\xi, \\
 c &= \mu + \alpha + \eta\theta, \\
 P_* &= \frac{\Lambda}{\mu\mathcal{R}_0}, \\
 S_* &= \frac{\mu(\mathcal{R}_0 - 1)}{\beta}, \\
 \mathcal{R}_0 &= \frac{\beta\omega c\Lambda}{\mu a(bc - \alpha\gamma\delta)},
 \end{aligned} \tag{A.2}$$

we can easily obtain

$$\begin{aligned}
 ab - \omega\beta P_* &= \frac{\alpha\gamma\delta a}{c}, \\
 \beta S_* &= \mu(\mathcal{R}_0 - 1), \\
 \mu + \beta S_* &= \mu\mathcal{R}_0, \\
 \beta\omega P_* c &= ax, \\
 \beta\omega P_* &= \frac{ax}{c}.
 \end{aligned} \tag{A.3}$$

Hence, we rewrite b_1, b_2, b_3, b_4 as follows:

$$b_1 = \mu\mathcal{R}_0 + a + b + c,$$

$$b_2 = \mu\mathcal{R}_0(a + b + c) + x + \frac{\alpha\gamma\delta a}{c} + ac,$$

$$b_3 = \mu\mathcal{R}_0\left(x + \frac{\alpha\gamma\delta a}{c} + ac\right) + \mu(\mathcal{R}_0 - 1)\frac{ax}{c},$$

$$b_4 = \mu(\mathcal{R}_0 - 1)ax.$$

In the following, we will calculate $b_1b_2b_3 - b_3^2 - b_1^2b_4$:

(A.4)

$$\begin{aligned} b_1b_2b_3 - b_3^2 - b_1^2b_4 &= (\mu\mathcal{R}_0 + a + b + c)\left(\mu\mathcal{R}_0(a + b + c) + x + \frac{\alpha\gamma\delta a}{c} + ac\right)\left(\mu\mathcal{R}_0\left(x + \frac{\alpha\gamma\delta a}{c} + ac\right) + \mu(\mathcal{R}_0 - 1)\frac{ax}{c}\right) \\ &\quad - \left(\mu\mathcal{R}_0\left(x + \frac{\alpha\gamma\delta a}{c} + ac\right) + \mu(\mathcal{R}_0 - 1)\frac{ax}{c}\right)^2 - (\mu\mathcal{R}_0 + a + b + c)^2\mu(\mathcal{R}_0 - 1)ax \\ &= d_1\mu + d_2\mu^2 + d_3\mu^3 + \left((a + b + c)d_4\mu + \frac{1}{c^2}d_5\mu^2 + d_6\mu^3\right)(\mathcal{R}_0 - 1) + (d_7\mu^2 + d_8\mu^3)(\mathcal{R}_0 - 1)^2 + d_9\mu^3(\mathcal{R}_0 - 1)^3, \end{aligned}$$

(A.5)

where

$$d_1 = (a + b + c)\left(x + ac + \frac{\alpha\gamma\delta a}{c}\right)^2,$$

$$d_2 = (a + b + c)^2\left(x + ac + \frac{\alpha\gamma\delta a}{c}\right),$$

$$d_3 = (a + b + c)\left(x + ac + \frac{\alpha\gamma\delta a}{c}\right),$$

$$d_4 = x^2 + \frac{ax(c^2 + \alpha\gamma\delta)}{c} + \frac{a^2(c^4 + 2c^2\alpha\gamma\delta + \alpha\gamma\delta(x + \alpha\gamma\delta))}{c^2},$$

$$\begin{aligned} d_5 &= 2c^2(b + c)^2x + c(2c^2 + x + 2\alpha\gamma\delta)(b^2 + c^2 + 3x + 2\alpha\gamma\delta)a \\ &\quad + (4c^4 + x^2 + c^2(x + 4\alpha\gamma\delta) + bc(4c^2 + x + 4\alpha\gamma\delta))a^2 + c(2c^2 + x + 2\alpha\gamma\delta)a^3, \end{aligned}$$

(A.6)

$$d_6 = \frac{1}{c}(3c(b + c)x + a^2(bc + 3c^2 + 2\alpha\gamma\delta) + a(b^2c + 6bc^2 + 3c^2 + 2b\alpha\gamma\delta)),$$

$$\begin{aligned} d_7 &= \frac{1}{c}(a\alpha\gamma\delta(2ab + b^2 + 3\alpha\gamma\delta) + a(ab + b^2 + 6\alpha\gamma\delta)x + 2ax^2) + a^2(ab + 4\alpha\gamma\delta) \\ &\quad + (2a^2 + b^2)x + ((a^3 + 3\alpha\gamma\delta) + (3a + 2b)x)c + (2a^2 + x)c^2 + ac^3, \end{aligned}$$

$$d_8 = \frac{1}{c}(3c(b + c)x + a^2(2x + 3c^2 + 3\alpha\gamma\delta) + a(3c^3 + 6bc^2 + 2bx + 3b\alpha\gamma\delta)),$$

$$d_9 = (b + c)(x + ab + ac + a^2).$$

Obviously $d_i > 0$, $i = 1, \dots, 9$. Note that $\mathcal{R}_0 > 1$; hence, $b_1b_2b_3 - b_3^2 - b_1^2b_4 > 0$. \square

B. The Third Additive Compound Matrix

The third additive compound matrix $A^{[3]}$ for a matrix $A = (a_{ij})_{4 \times 4}$ is given by

$$A^{[3]} = \begin{bmatrix} a_{11} + a_{22} + a_{33} & a_{34} & -a_{24} & a_{14} \\ a_{43} & a_{11} + a_{22} + a_{44} & a_{23} & -a_{13} \\ -a_{42} & a_{32} & a_{11} + a_{33} + a_{44} & a_{12} \\ a_{41} & -a_{31} & a_{21} & a_{22} + a_{33} + a_{44} \end{bmatrix}. \quad (\text{B.1})$$

Data Availability

In this paper, partial parameter values are cited from the previous literatures which are listed in our references. Due to the lack of the available literatures and data, the other parameter values are based on some reasonable assumptions (see details in Section 3.3). All of the Matlab codes which are related to this paper can be provided at any time.

Conflicts of Interest

The authors declare that there are no conflicts of interest regarding the publication of this article.

Acknowledgments

This work was partially supported by the National Natural Science Foundation of China (nos. 11371164 and 11871060), the Natural Science Foundation of Henan Province of China under grants 182102410021 and 182102410067, the Young Backbone Teacher of Huanghuai University, the Young Backbone Teacher of Henan Province, Henan International Joint Laboratory of Behavior Optimization Control for Smart Robots (file no. [2018]19), the Programme of Henan Innovative Research Team of Cooperative Control in Swarm-Based Robotics, and the Self-Determined Research Funds of CCNU from the Colleges' Basic Research and Operation of MOE (grant no. CCNU16JCZX10).

References

- [1] Centers for Disease Control and Prevention, *Smoking and Tobacco Use*, Centers for Disease Control and Prevention, Atlanta, GA, USA, 2018, <http://www.cdc.gov/tobacco/datastatistics/factsheets/fastfacts/>.
- [2] World Health Organization, *Policy Recommendations for Smoking Cessation and Treatment of Tobacco Dependence*, World Health Organization, Geneva, Switzerland, 2003, <http://www.who.int/tobacco/resources/publications/tobaccodependence/en/>.
- [3] World Health Organization, *Global Action Against Cancer*, World Health Organization, Geneva, Switzerland, 2002, <http://www.who.int/cancer/media/en/GlobalActionCancerEnglfull.pdf>.
- [4] Framework convention alliance for tobacco control, *Tobacco cessation and treatment*, 2009, <http://old.ensp.org/files/05cessationandtreatment.pdf>.
- [5] Wikipedia, *smoking cessation*, 2018, <https://en.wikipedia.org/wiki/Smokingcessation>.
- [6] World health organization, *Which are the Most Effective and Cost-Effective Interventions for Tobacco Control?*, World Health Organization, Geneva, Switzerland, 2003, <http://www.euro.who.int/data/assets/pdf/0004/74722/E82993.pdf>.
- [7] O. K. Ham, "Stages and processes of smoking cessation among adolescents," *Western Journal of Nursing Research*, vol. 29, no. 3, pp. 301–315, 2007.
- [8] S. T. Yen, W. D. Shaw, and Y. Yuan, "Cigarette smoking and self-reported health in China," *China Economic Review*, vol. 21, no. 4, pp. 532–543, 2010.
- [9] V. S. Ertürk, G. Zaman, and S. Momani, "A numeric-analytic method for approximating a giving up smoking model containing fractional derivatives," *Computers & Mathematics with Applications*, vol. 64, no. 10, pp. 3065–3074, 2012.
- [10] G. C. Castillo, S. G. Jordan, and H. A. Rodriguez, "Mathematical models for the dynamics of Tobacco user recovery and relapse," *Public Health*, vol. 84, no. 4, pp. 543–547, 1997.
- [11] O. Sharomi and A. B. Gumel, "Curtailing smoking dynamics: a mathematical modeling approach," *Applied Mathematics and Computation*, vol. 195, no. 2, pp. 475–499, 2008.
- [12] F. Guerrero, F. J. Santonja, and R. J. Villanueva, "Solving a model for the evolution of smoking habit in Spain with homotopy analysis method," *Nonlinear Analysis: Real World Application*, vol. 14, no. 1, pp. 549–558, 2013.
- [13] C. D. Rowe, L. Chassin, C. C. Presson, D. Edwards, and S. J. Sherman, "An "epidemic" model of adolescent cigarette smoking," *Journal of Applied Social Psychology*, vol. 22, no. 4, pp. 261–285, 1992.
- [14] A. Zeb, G. Zaman, and S. Momani, "Square-root dynamics of a giving up smoking model," *Applied Mathematical Modeling*, vol. 37, no. 7, pp. 5326–5334, 2013.
- [15] A. Lahrouz, L. Omari, D. Kiouach, and A. Belmaati, "Deterministic and stochastic stability of a mathematical model of smoking," *Statistics & Probability Letters*, vol. 81, no. 8, pp. 1276–1284, 2011.
- [16] F. Guerrero, F. J. Santonja, and R. J. Villanueva, "Analysing the Spanish smoke-free legislation of 2006: a new method to quantify its impact using a dynamic model," *International Journal of Drug Policy*, vol. 22, no. 4, pp. 247–251, 2011.
- [17] Canadian Cancer Society, *Evaluation of New Warnings on Cigarette Packages*, Canadian Cancer Society, Toronto, Canada, 2002, <http://www.cancer.ca/>.
- [18] L. Pang, Z. Zhao, S. Liu, and X. Zhang, "A mathematical model approach for tobacco control in China," *Applied Mathematics and Computation*, vol. 259, pp. 497–509, 2015.
- [19] P. V. D. Driessche and J. Watmough, "Reproduction numbers and sub-threshold endemic equilibria for compartmental models of disease transmission," *Mathematical Biosciences*, vol. 180, no. 1–2, pp. 29–48, 2002.
- [20] J. Muldowney, "Compound matrices and ordinary differential equations," *Rocky Mountain Journal of Mathematics*, vol. 20, no. 4, pp. 857–872, 1990.
- [21] M. Li and J. Muldowney, "A geometric approach to global stability problems," *SIAM Journal on Mathematical Analysis*, vol. 27, no. 4, pp. 1070–1083, 1996.
- [22] M. Li, J. Muldowney, and P. Driessche, "Global stability of SEIRS models in epidemiology," *Canadian Applied Mathematics Quarterly*, vol. 7, pp. 409–425, 1999.

- [23] M. Li and J. Muldowney, "Dynamics of differential equations on invariant manifolds," *Journal of Differential Equations*, vol. 168, no. 2, pp. 295–320, 2000.
- [24] J. Tumwiine, J. Mugisha, and L. Luboobi, "Threshold and stability results for a malaria model in a population with protective intervention among high-risk groups," *Mathematical Modelling and Analysis*, vol. 13, no. 3, pp. 443–460, 2008.
- [25] Y. Cheng, J. Wang, and X. Yang, "On the global stability of a generalized cholera epidemiological model," *Journal of Biological Dynamics*, vol. 6, no. 2, pp. 1088–1104, 2012.
- [26] A. Goyal, "Tobacco epidemics: effect of marketing bans and awareness programs on its spread," *Applied Mathematics and Computation*, vol. 247, pp. 1030–1051, 2014.
- [27] K. Okosun, R. Ouifki, and N. Marcus, "Optimal control analysis of a malaria disease transmission model that includes treatment and vaccination with waning immunity," *Biosystems*, vol. 106, no. 2–3, pp. 136–145, 2011.
- [28] K. Okosun, O. Rachid, and N. Marcus, "Optimal control strategies and cost-effectiveness analysis of a malaria model," *Biosystems*, vol. 111, no. 2, pp. 83–101, 2013.
- [29] F. Agosto, "Optimal isolation control strategies and cost-effectiveness analysis of a two-strain avian influenza model," *Biosystems*, vol. 113, no. 3, pp. 155–164, 2013.
- [30] H. Joshi, "Optimal control of an HIV immunology model," *Optimal Control Applications and Methods*, vol. 23, no. 4, pp. 199–213, 2002.
- [31] E. Jung, S. Lenhart, and Z. Feng, "Optimal control of treatments in a two-strain tuberculosis model," *Discrete and Continuous Dynamical Systems Series B*, vol. 2, no. 4, pp. 473–482, 2002.
- [32] D. Kirschner, S. Lenhart, and S. Serbin, "Optimal control of the chemotherapy of HIV," *Journal of Mathematical Biology*, vol. 35, no. 7, pp. 775–792, 1997.
- [33] D. Kern, S. Lenhart, R. Miller, and J. Yong, "Optimal control applied to native-invasive population dynamics," *Journal of Biological Dynamics*, vol. 1, no. 4, pp. 413–426, 2007.
- [34] L. Pang, S. Ruan, S. Liu, Z. Zhao, and X. Zhang, "Transmission dynamics and optimal control of measles," *Applied Mathematics and Computation*, vol. 256, pp. 131–147, 2015.
- [35] L. Pontryagin, V. Boltyanskii, R. Gamkrelidze, and E. Mishchenko, *The Mathematical Theory of Optimal of Optimal Processes*, Wiley, New York, NY, USA, 1962.
- [36] J. Karrakchou, M. Rachik, and S. Gourari, "Optimal control and infectiology: application to an HIV/AIDS model," *Applied mathematics and computation*, vol. 177, no. 2, pp. 807–818, 2006.
- [37] V. Brown and K. Jane White, "The role of optimal control in assessing the most cost-effective implementation of a vaccination programme: HPV as a case study," *Mathematical Biosciences*, vol. 231, no. 2, pp. 126–134, 2011.
- [38] A. Lashari and G. Zaman, "Optimal control of a vector borne disease with horizontal transmission," *Nonlinear Analysis: Real World Applications*, vol. 13, no. 1, pp. 203–212, 2012.
- [39] D. Lukes, *Differential Equations: Classical to Controlled, Mathematics in Science and Engineering*, Academic Press, New York, NY, USA, 1982.
- [40] P. Rodrigues, C. Silva, and D. Torres, "Cost-effectiveness analysis of optimal control measures for tuberculosis," *Bulletin of Mathematical Biology*, vol. 76, no. 10, pp. 2627–2645, 2014.
- [41] S. Lenhart and J. Workman, *Optimal Control Applied to Biological Models*, Chapman Hall/CRC, BocaRaton, FL, USA, 2007.
- [42] L. Pang, Z. Zhong, and X. Song, "Cost-effectiveness analysis of optimal strategy for tumor treatment," *Chaos, Solitons & Fractals*, vol. 87, pp. 293–301, 2016.